

TRADING, CONTRACTING, CONSTRUCTION & ENGINEERING

VEHICLE & MACHINERY

CORROSION CONTROL COATING & OTHER SERVICES

STEEL PIPE MANUFACTURING

NAILS & GALVANIZED WIRE MANUFACTURING

WATER TREATMENT CHEMICALS

WATER PLANT

INDUSTRIAL & MEDICAL GASES

BULK FOOD PACKAGING

CEILING SYSTEM

TRAVEL SERVICES

GENERAL INSURANCE

PIPE INSPECTION & TESTING

TRANSPORTATION & CUSTOM CLEARANCE

FARMING

EDUCATION SERVICES

OVERSEAS SERVICES



**ABDEL HADI ABDULLAH  
AL-QAHTANI & SONS**  
TARIQ ABDEL HADI AL-QAHTANI & BROTHERS

# هَذَا مِنْ فِضْلِ رَبِّي



**Sheikh Abdel Hadi Abdullah Al-Qahtani**

*(Founder)*

1901 - 1991



**Tariq Abdel Hadi Al-Qahtani**  
*(Chairman of the Board)*



**Salah Abdel Hadi Al-Qahtani**  
*(Vice Chairman)*



**Abdullah Abdel Hadi Al-Qahtani**  
*(Vice President)*



# I N D E X

<ul style="list-style-type: none"> <li>● <b>Trading &amp; Contracting</b></li> </ul>	<ul style="list-style-type: none"> <li>● <b>Abdel Hadi Abdullah Al-Qahtani &amp; Sons Co.</b> <ul style="list-style-type: none"> <li>• Oil &amp; Gas Supplies and Services Division</li> <li>• Construction &amp; Engineering Division</li> <li>• Environmental Services Division</li> <li>• Specialized projects Division</li> <li>• Integrated Security &amp; Communication System Solution</li> <li>• Food Division</li> <li>• Real Estate Investment Division</li> </ul> </li> <li>● <b>Pipe &amp; Well Services Establishment</b></li> <li>● <b>Al-Qahtani Vehicle &amp; Machinery</b></li> </ul>
<ul style="list-style-type: none"> <li>● <b>Industry</b></li> </ul>	<ul style="list-style-type: none"> <li>● <b>Al-Qahtani Pipe Coating Industries</b></li> <li>● <b>Group Five Pipe Saudi Ltd.</b></li> <li>● <b>Al-Qahtani Nails &amp; Galvanized Wire Factory</b></li> <li>● <b>Al-Jazira Water Treatment Chemicals</b></li> <li>● <b>Al-Jazirah Water Company</b></li> <li>● <b>Southern Gas Company</b></li> <li>● <b>Bulk Food Packaging</b></li> <li>● <b>International Ceiling Systems Factory</b></li> <li>● <b>Riyadh Polypropylene Woven Sacks Co.</b></li> <li>● <b>Güssinger Beverages &amp; Mineral Water GmbH</b></li> </ul>
<ul style="list-style-type: none"> <li>● <b>Services</b></li> </ul>	<ul style="list-style-type: none"> <li>● <b>Arabian Commercial Services Co. Ltd.</b></li> <li>● <b>Abdel Hadi Al-Qahtani Travel Bureau</b></li> <li>● <b>Earadat Transport Co.</b></li> <li>● <b>Earadat Custom Clearance</b></li> <li>● <b>Shams Al-Jazirah School (Girls)</b></li> </ul>
<ul style="list-style-type: none"> <li>● <b>Farming</b></li> </ul>	<ul style="list-style-type: none"> <li>● <b>Riyadh • Dammam • Abha</b></li> </ul>
<ul style="list-style-type: none"> <li>● <b>Overseas Services</b></li> </ul>	<ul style="list-style-type: none"> <li>● <b>Saudi Arabian Overseas Services Inc. (U.S.A.)</b></li> <li>● <b>A.H.Q. Suisse SA</b></li> <li>● <b>H.T. International for General Trading &amp; Contracting (Kuwait)</b></li> <li>● <b>Bahrain Office</b></li> <li>● <b>Egypt Office</b></li> <li>● <b>Sudan Office</b></li> <li>● <b>Austria Office</b></li> <li>● <b>China Office</b></li> <li>● <b>Nouakchott - Mauritania</b></li> </ul>

## General Information

<b>Name</b>	: Abdel Hadi Abdullah Al-Qahtani & Sons Group of Companies (Tariq Al-Qahtani & Bros.)
<b>Head Office</b>	: P. O. Box 20 – Dammam 31411, Saudi Arabia
<b>Phone</b>	: +966-3-826-1477 / 826-1635 / 826-1831
<b>Fax</b>	: +966-3-826-9894
<b>E-mail</b>	: info@abdelhadiqhtanisons.com / info@ahqsons.com
<b>Website</b>	: www.ahqsons.com

## Owners & Board Members

<b>Chairman of the Board</b>	: Tariq Abdel Hadi Al-Qahtani
<b>Executive Vice President</b>	: Salah Abdel Hadi Al-Qahtani
<b>Vice President</b>	: Abdullah Abdel Hadi Al-Qahtani



**P**

**U**

**O**

**R**

**G**

# **Abdel Hadi Abdullah Group of Companies**

**(Tariq Al-Qahtani & Bros.)**

**T**he Group initially started its business with its first company i.e. Abdel Hadi Abdullah Al-Qahtani & Sons Co. in the early 40's of the 20th century as a wholesaler and supplier of food products. As the business grew and expanded, it diversified into supplying other industries including Petrochemicals, Oil & Gas Exploration and Gathering Systems, Refineries, Fertilizer Plants, Desalination and other energy related fields. Apart from energy related and industrial supplies and the long established wholesale Food Division, the Group furnishes Medical instruments and Supplies, Recreational Equipment, Computer software and hardware, other I.T. services, consumer products and vehicle & machinery.

The Group has gradually moved towards industry in major oil and gas and non-oil and gas related activities. Huge investment and facilities in pipe corrosion control services, manufacturing of medium and large diameter steel pipes, water treatment chemicals, nails and galvanized wire manufacturing, industrial and medical gases, water bottling, and bulk food packaging now form a major part of the Group's activities.

The Group has not overlooked the services side of its activities but has created from time to time added new activities such as Insurance, Travel & Tourism, Transportation and Custom Clearance, besides the other specialized services such as Pipe Inspection, Environmental Protection, Real Estate Investment, Car Parking services and others.



# Al-Qahtani & Sons

The Group has established a presence in the Contracting and Construction Industry and is a leader in new technologies and is associated with well-known industries to carry out major projects in the Kingdom. Furthermore, the Group owns vast areas of agricultural land used for wheat and cereal farming, fruit tree plantations, and breeding of cattle and pure Arabian Horses. On the other hand, the Group in order to diversify its investment portfolio in the early 70's established a full-fledged company in Houston, the U.S. Oil Capital. Other sister companies were also established in the G.C.C. and other Middle East countries to help promote business within the area and enhance the image of the Group.

The Group is involved with international firms in joint venture manufacturing projects.

A staff of highly qualified and dedicated professionals operates the business. Customer service is a priority and is facilitated by a wide variety of technical expertise and experienced personnel employed by the Group. The Group is managed by leaders with vision and ambition, dedicated to developing further opportunities in partnership with new and existing clients.

Business activities have extended to other Middle Eastern Countries. The Group has an excellent reputation as a long established supplier of materials, equipment, engineering services and other products to Saudi Aramco, SEC, SABIC, SWCC and many other Government Agencies as well as the Private Sector.



## Abdel Hadi Abdullah Al-Qahtani & Sons Co.

### Oil Field Supplies & Services Division

The division is involved since early 50's in supply of Oil Field Products and Services in the Kingdom. SAUDI ARAMCO & other Oil Companies, Petro-Chemical Industries, Utility Companies, EPC/Pipeline Contractors, Military and Educational Institutions have been our main clients.

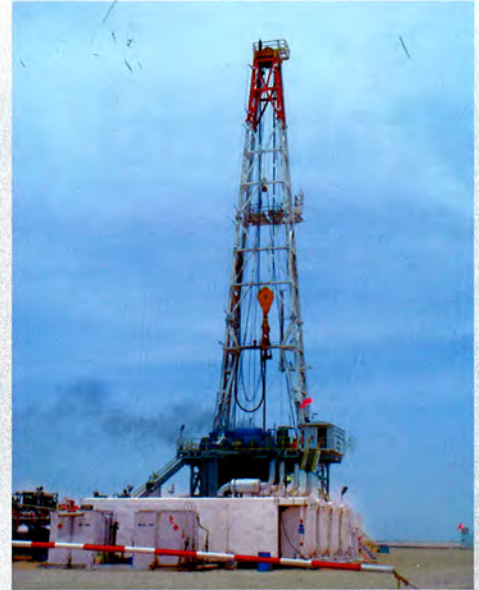

### Material Supplies

- Casing/Tubing, Drill Pipes & Well Head Equipments
- Pipes (SAW, ERW, Seamless), Flanges, Pipe Bends, Pipe Fittings (Butt Weld & Forged).
- Gas Turbines, Compressors (Air & Gas Reciprocating), Pumps (injection pumps, high pressure jetting pumps, centrifugal pumps), Gears.



Gate Valves

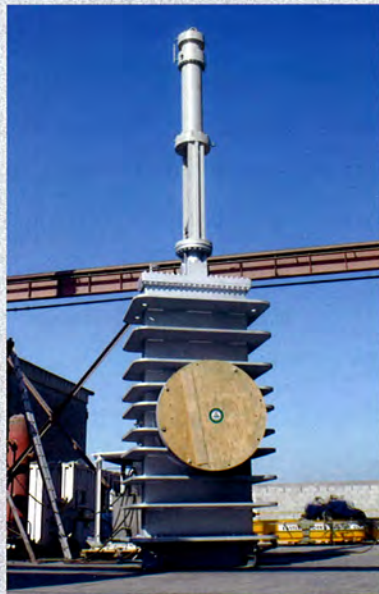

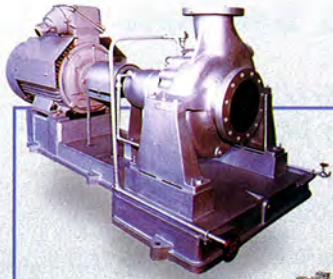

Single Stage Center Line Supported Process Pumps



Horizontal Double Case Multi-Stage Pumps



Corrosion Inhibitor Injection Skid

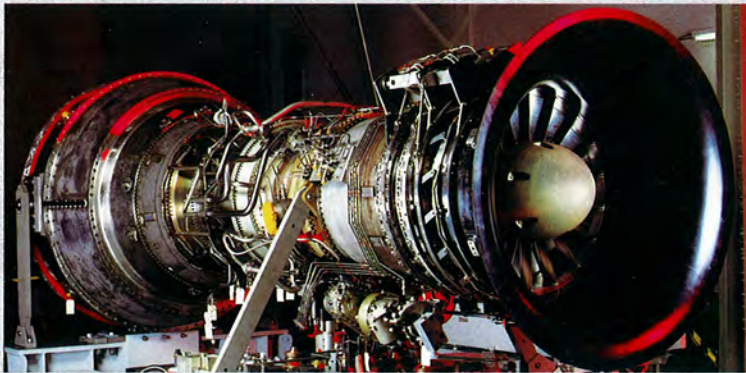

Gas Turbine



**Industries utilising INPIPE products**

- Oil Refining
- Gas Processing
- Offshore Oil & Gas Industry
- Petro-chemical
- Fine Chemical
- Nuclear
- Power Industry
- Products Industry
- Water Industry
- Paint & Dye Industry
- Food & Beverage Industry
- Coal & Aggregates
- Sewage & Effluents
- Environmental

INPIPE Products



HYTORC Tools

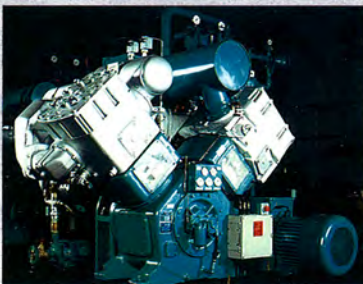

Reciprocating Air Compressor



Oil Recovery Systems

## Material Supplies (Contd.)

- Valves (Gate, Globe, Ball, Check, Plug, Butterfly, Control)
- Pipelines Cleaning Scrapers, Scrapper Traps, Scrapper Passage indicators, Pipe Supports & Hangers, Expansion Joints, Pipeline stoppers
- Pipeline Flow Improver (DRA).
- Marine Hoses, Marine Ropes, Fenders, Oil Booms, Marine Loading Arms, Tug Boats, Rescue Boats
- Fire & Safety System & Equipment, Gas Detection System, Foam Skids
- Desalters, Dehydrators, Oily Water Separators, Centrifuges, Gas Conditioning Systems, Mist Eliminators, Coalescers
- Motor Protection Relays, Cable Fault Location Equipment
- Laboratory Equipments, Pilot Plants
- Hydraulic Torque Wrenches





**TRADING & CONTRACTING**

Oil Country TUBULAR  
Goods (OCTG)

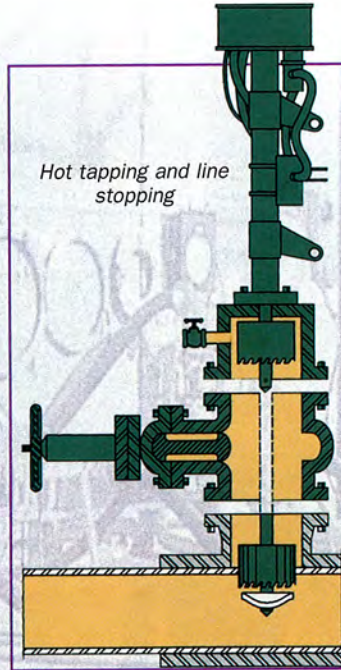

## Oil Field Services

- Restoration of Heat Exchangers & Condenser Tubes
- Cleaning of Heat Exchanger & Condenser Tubes
- Repair, Maintenance & Overhauling of Gas Turbines & Compressors



Gas Valves

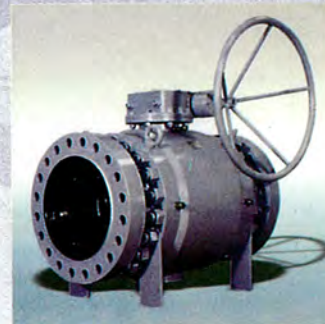

Side entry ball valve



Pressure seal valves



Generation

Transmission & Distribution

Motors

Meters

Telecommunications



**GE Multilin**

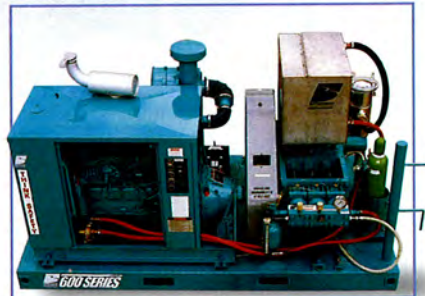

Hydro Ejecting Pump

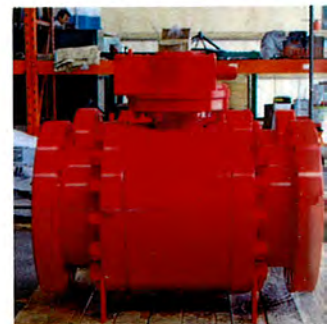

Swing Check valve

### Contact:

Division Manager

P. O. Box 20, Dammam 31411, Kingdom of Saudi Arabia, Tel.: 966 3 826 1477 / 1635, Fax: 966 3 826 9894  
E-mail: info@ahqsons.com, Website: www.ahqsons.com





## Construction & Engineering Division

The Company established a Construction & Engineering Division in the early 90's to execute its projects in the field of Mechanical, Civil, Electrical and Instrumentation disciplines associated with major international companies to execute several projects in the Kingdom of Saudi Arabia.

The Division has completed a few projects during the last few years involving:

- Supply and Erection of Cooling Towers at the King Fahd Military Medical Center.
- Engineering Design, Supply and Installation of Fuel Gas Dust/Liquid Separator Equipment in SEC Qurayyah Power Plant.
- Grease and Seal Well-head Valves in the ARAMCO Industry.
- Refurbishment of Waste-water tanks at King Fahd Military Medical Center.
- Study of corrosion, engineering and supply of Heat Exchangers / Boiler Tube Shield and their installation in ARAMCO and SABIC Industries.

The Construction & Engineering Division in association with international companies also worked with all aspects of Power Plant Project Initiation, Feasibility Appraisals, Site Evaluation, Conceptual Engineering Modeling and Design, Financial Planning, Design, Procurement, Execution and Start-up, Training and subsequent Operation and Maintenance.

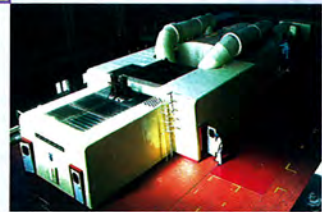

### Contact:

Division Manager

P. O. Box 20, Dammam 31411, Kingdom of Saudi Arabia, Tel.: 966 3 826 1477 / 1635, Fax: 966 3 826 9894  
E-mail: info@ahqsons.com, Website: www.ahqsons.com





## Environmental Services Division

The Company has taken the initiative of expanding in the field of Environmental Engineering Services. In a common trend with other countries there is a growing concern for safeguarding the environment and clean up of hazardous waste in the Middle East. The Company has acquired and set up a complete facility to treat oily waste through state of the art technology.

The facility's equipment is manufactured by one of the world leader's in centrifugal separation technology. The latest technology is part of their wide range of separation equipment.

The Company by executing several projects for Saudi Aramco in the Kingdom, is well placed and equipped with the machinery, systems, qualified man power and logistical support to carry out oily waste recovery and clean up projects.

The significant advantages of the treatment system are:

- Reduction of health risk and environmental damage by minimizing waste and the subsequent proper disposal of remaining pollutants.
- Oil is separated and segregated for return to proper storage where it becomes a usable product.
- Water is separated and hydrocarbon contents treated and reduced to acceptable discharge levels. The water is then redirected to a water treatment plant or released.
- Solids are reduced to a near dry state. The waste thus dramatically reduced in volume has been stabilized. It can be disposed off in accordance with applicable environmental policies.



### Contact:

Division Manager

P. O. Box 20, Dammam 31411, Kingdom of Saudi Arabia, Tel.: 966 3 826 1477 / 1635, Fax: 966 3 826 9894  
E-mail: info@ahqsons.com, Website: www.ahqsons.com





## Integrated Security & Communication Systems Solution

# AHQ

Integrated security & communication systems solution was established to cater the ever-growing needs of highly sophisticated electronic & physical security, surveillance and communication as well as IT sector for Government, Semi Government and Private Sector as well as major organizations like MARFIQ SAUDI ARAMCO, SEC, SWCC, SABIC etc.

Over the years the integrated security & communication systems has established long term business relationship with international suppliers for the complete low current security & communication systems starting from CCTV, Access Control, Fire Alarm, Gate Barrier, Security Locking Solution, Intruder/Burglar Alarm, Perimeter Security etc., And for communication sophisticated IP networks, IPTV, CATV, PA, audio visual, SIS, Conference System etc. Also highly sophisticated security solutions such as, X-ray Scanning, Walk Through, Hand Held, Explosive Detectors and Military Supplies such as Bulletproof Vest, Helmets, Radars etc.

As a provider of Customized, fully integrated systems; AHQ undertakes all activities ranging from Concept, Design, Engineering, Integration, Installation, Testing, Commissioning and Maintenance. The strength of AHQ lies in working with manufacturers expert in their field, incorporation of latest available technology in its systems, expertise with analog as well as IP networks and wired/wireless communication media, for the integration of systems customized to clients needs and requirements, to any scale of deployment.

The hallmark of our systems is intelligent command and control to achieve a qualitative, proactive user response to potential threats and smart analysis to aid objective decision making and planning.

During our past years AHQ has remained focused in its chosen field of business. We stand solid on a strong reputation and the trust of our clients. It is not surprising therefore that over the years we were presented with challenging projects which we executed successfully.



### Contact:

Division Manager

P. O. Box 20, Dammam 31411, KSA, Tel.: 966 3 845 0700 / 826 1477 / 1635, Fax: 966 3 845 0701 / 826 9894  
E-mail: itd@ahqsons.com, Website: www.ahqsons.com





## Food Division

**F**ood Division is a part of **Abdel Hadi Abdullah Al-Qahtani & Sons Company** (Mother Company) which was established in 1948 in Eastern province of Kingdom of Saudi Arabia to import and distribute food and consumer products to domestic market. The soul policy of the division has been to select the best international products all over the world and to fulfill the needs of the market. The **Food Division** gradually prevailed several agencies agreement for many products that are still playing an important contribution over 45 years due to its efficient services through branches in all main cities in the Kingdom.

## Facilities

The **Food Division** has strong net work of offices in Kingdom wide with large warehousing facilities, delivery trucks/vans and professional sales team to efficiently handle the customer's need in effective manner. The warehouses are over 12,000 square meters with modern equipments for the smooth handling of materials.

## Market Trend

The strategy was to accompany and harmonize with the market trends from suppliers to wholesalers and it was driven to focus directly on the retailers' front as per the direction of the top management which provided also all supports and services to the division's need. All the above paved, Food Division has covered considerably the market share in all market segments.

## Developments

Our strategy to enter in exploring best products those are in accordance with the need of consumer in our market. The division has earmarked an area in our warehouses to develop cold enclave in order to enter into frozen food business considering the large market size of this particular category. In addition the Division is involved in looking for joint venture in the field of food processing in order to cover more market share in Saudi Arabia.



### Contact:

Division Manager

P. O. Box 20, Dammam 31411, Kingdom of Saudi Arabia, Tel.: 966 3 826 1477 / 1635, Fax: 966 3 826 9894  
E-mail: food@ahqsons.com, Website: www.ahqsons.com





## Real Estate Investment Division

The division is involved in investing and developing real estate for both residential and commercial purposes by buying and selling buildings and real estate within the Kingdom, some neighboring Arab countries and in Houston, USA.

A highly specialized team is involved in the real estate business having excellent experience in conducting studies on the real estate market to get complete and up-to-date information about the market dynamics and the investment climate.



### Contact:

Division Manager

P. O. Box 20, Dammam 31411, Kingdom of Saudi Arabia, Tel.: 966 3 826 1477 / 1635, Fax: 966 3 826 9894  
E-mail: [info@ahqsons.com](mailto:info@ahqsons.com), Website: [www.ahqsons.com](http://www.ahqsons.com)





## Pipe & Well Services Establishment

**P**WS, an ISO 9001 certified company, was incorporated in 1992 to provide a wide range of inspection, testing and certification services to the oil and petroleum industry. There was a need in the market to provide high quality services at very competitive rates through a professionally organized Company, which enjoys the reputation and creditability of overseas inspection companies.

PWS is the tubular inspection specialist company in Al-Qahtani & Sons Group of Companies which has grown up in multiples in last ten years matching with latest technologies and development.

PWS is successfully continuously serving SAUDI ARAMCO since 1996. Recent achievement of the 4th contract from SAUDI ARAMCO has added feather in cap. There is a wide range other than oil & petroleum industries customers where company is serving since long period. It's very sure that our inspection expertise will raise your satisfaction level to high position.

### Services

PWS offers various services to industry through inspection teams consisting of qualified and certified inspectors (ASNT certified) and have performed inspection jobs throughout Saudi Arabia. The company is accepted as a well-reputed organization related to inspection, testing and certification services:



## Oil Country Tubular Goods (OCTG)

### Inspection Services

- A. New/Used Drill Pipe Inspection
- B. Bottom Hole Assembly Inspection
- C. Various Drilling Tools Inspection
- D. Rig Parts and Handling Tools Inspection
- E. New/Used Tubing and Casing Inspection Services:
- F. Dye Penetrant Inspection of NMDC and Chrome Parts
- G. Tubular Cleaning Services
- H. Straightening of Tubulars
- I. Shoulder Re-facing
- J. Coupling Buck on/off
- K. Mill Slotting
- L. Hardness test

### Inspections carried out to API and DS-1 Specifications

### Other Inspection Services

- A. Non-Destructive Examination (NDE) Services
- B. Ultrasonic Thickness Measurements, A-Scan and B-Scan
- C. Ultrasonic Flaw Detection
- D. Various types of Magnetic Particle Testing (MPT)
- E. Visible MPT with A/C Hand Yoke, Black & White Contrast
- F. Various types of Liquid Penetrant Testing (LPT)
- G. Lifting Equipment & Accessories Testing
- H. Inspection Training and Certification Services
- I. Bore scope by using Video scope and/or optiscope

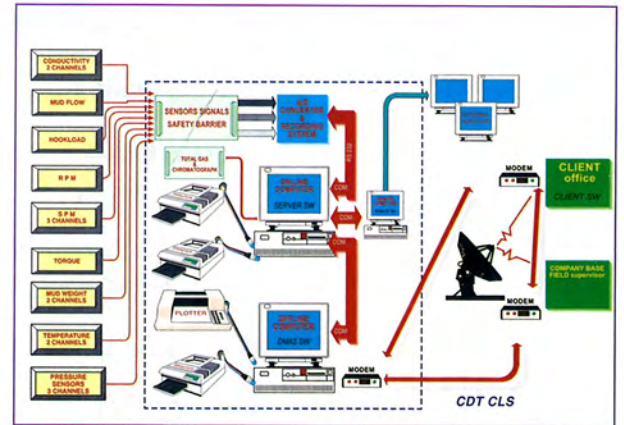

CDT Compact Logging System ( CLS )

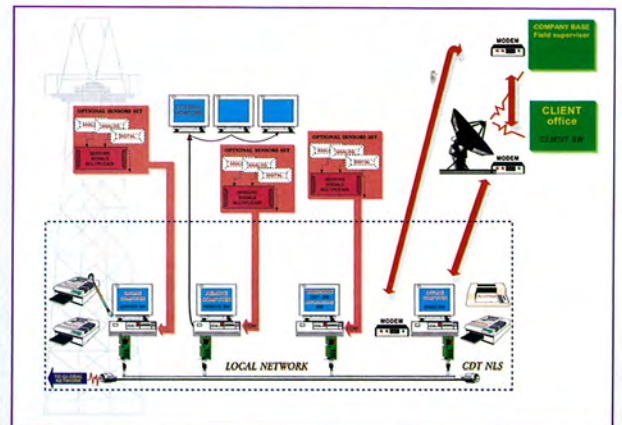

CDT Network System



### Contact:

Division Manager

P. O. Box 2010, Dammam 31451, Kingdom of Saudi Arabia, Tel.: 966 3 859 2286 / 859 4716, Fax: 966 3 859 3772  
E-mail: info@pipewellservices.com, Website: www.ahqsons.com

**AHQ**





## Al-Qahtani Vehicle & Machinery

We are the dealer for the following:

**LIUGONG** Earth-Moving Equipment in Saudi Arabia, Bahrain, & Qatar.

**TEREX** Rough-Terrain cranes, Tower cranes, Crawler cranes in Saudi Arabia & Bahrain.

**GENIE** Representation of Aerial platforms.

**JIATAI** Generator sets & Welding machines.

**CHENGLONG** Trucks.

We are also one of the strategic account clients for LIUGONG, TEREX & JIATAI.





The main goal of our company is to provide maximum professional service that will meet and exceed customer's expectations.

Our main target is to gain our client's satisfaction through the introduction of our Best Average Package.

1. Reliable product,
2. Spare parts availability, &
3. Unmatched service.



**Contact:**

Division Manager

P. O. Box 20, Dammam 31411, Kingdom of Saudi Arabia, Tel.: 966 3 826 1477/1635, Fax: 966 3 826 9894  
 E-mail: info@ahqsons.com/khaled.shatoury@ahqsons.com, info@ahqmachinery.com  
 Website: www.ahqsons.com





## Al-Qahtani Pipe Coating Industries

The Kingdom of Saudi Arabia has experienced major developments in the pipeline industries. To meet the demands of the harsh environment and for the protection of Cross-Country and Sub-Sea Oil, Water and Gas Pipelines against corrosion. Al-Qahtani Pipe Coating Industries was established in 1954. Since those early days when coat and wrap was used. The company has rapidly moved to new technological advantages available today and has three separate facilities in the Kingdom equipped with the latest coating technology.

### Internal Fusion Bonded Epoxy Coating

Al-Qahtani Pipe Coating applying FBE to internal surfaces of Pipes, Fittings, Spools and downhole tubular's FBE can apply for sizes from 2-1/2" to 80" OD. Internal fusion bonded Epoxy Coating can be used for treated seawater service, sour gas, Gtude service, Wasia water service and potable water.

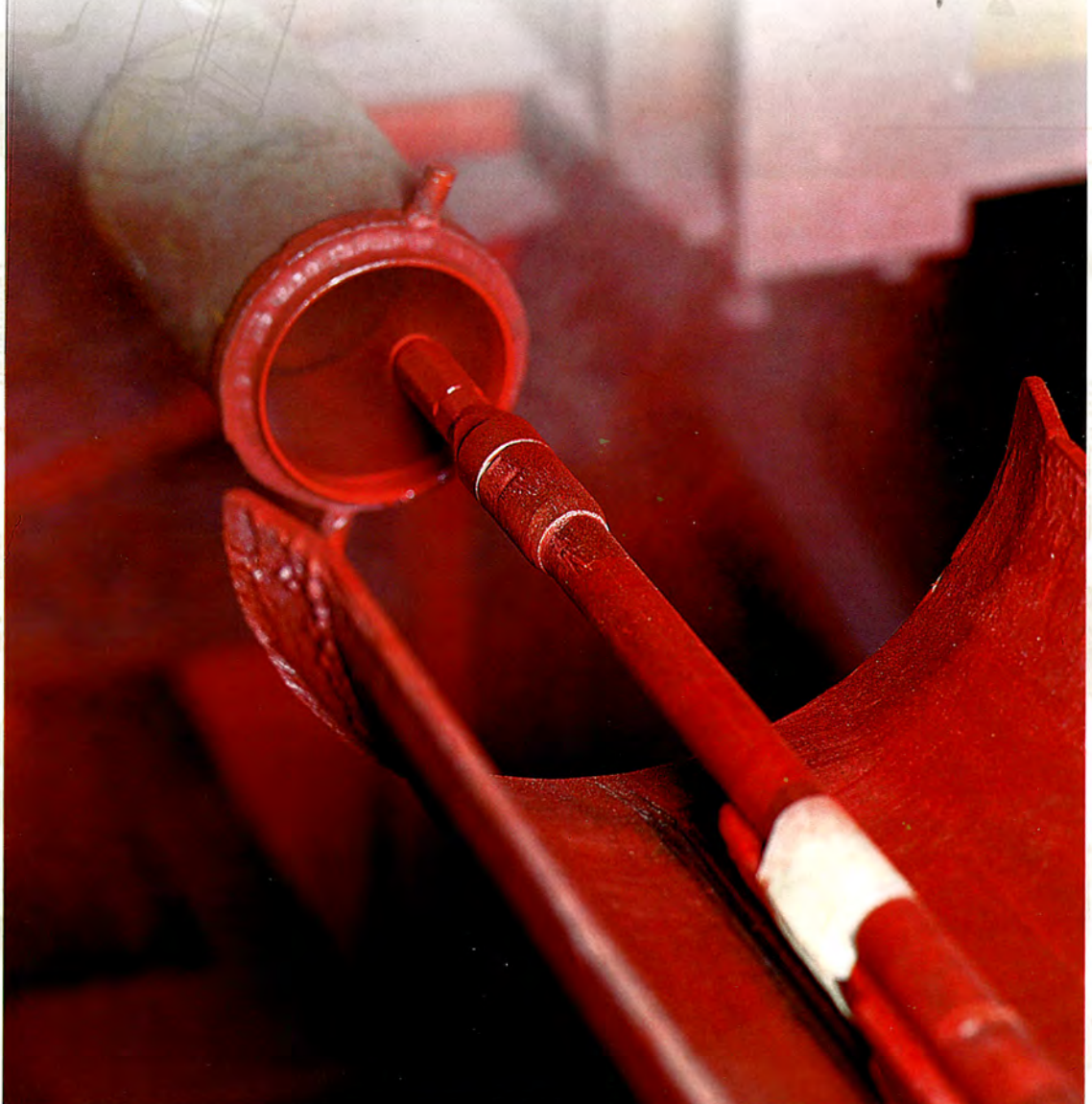



### Double Jointing

Since 1978 the Double Jointing Plant utilizes a 5 station Double – Jointing system to join two 40 foot sections of pipe into one 80 foot section for diameter of 10” to 60”

Double jointing contributes to substantial transportation savings and reduces the number of field weld by one – half. After the welding is completed 100% X-Ray is performed our radiographic film processing facility is equipped with two fully automatic film processing units for speed and reliability.



### Internal Shop or Field Girth Weld Coating

Al-Qahtani Pipe Coating developed the capability to coat the internal girth weld area of the coated pipe from 10” and up to 60” diameter. Capabilities can be developed for larger diameters if so required by clients. The service contributes to providing an end-to-end corrosion protection system with fusion bonded epoxy using.

The most modern internal robotic equipment.

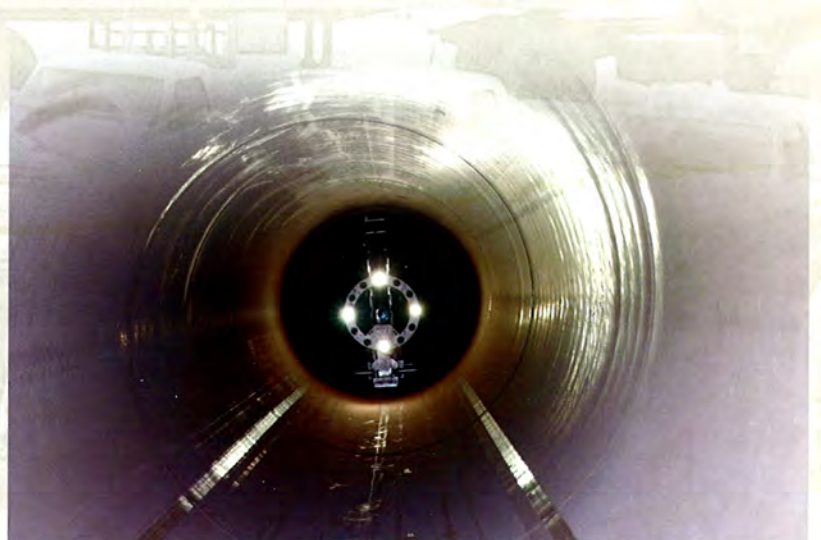

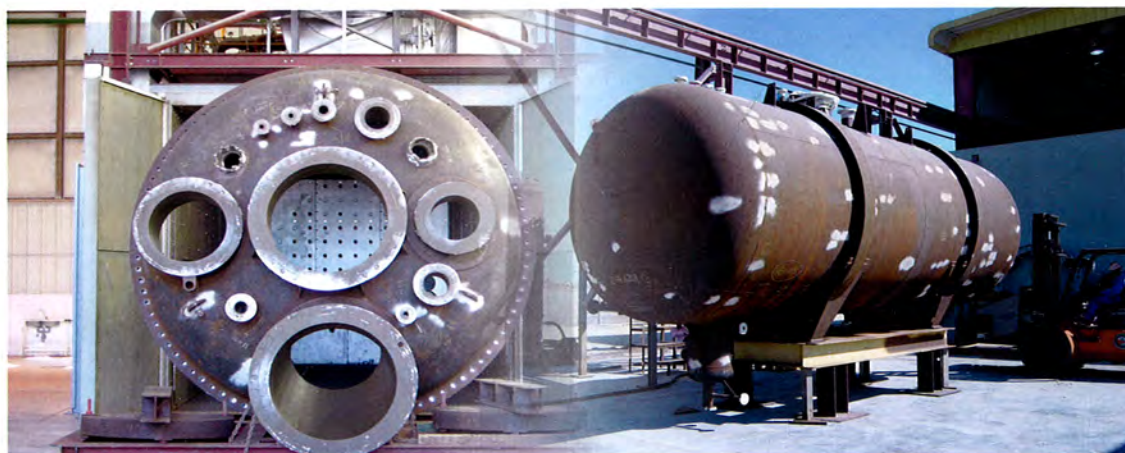

### Coating for Heat Exchangers, Vessels and Boilers

Applied coating on internal and external surface of tube bundles, vessels, tanks to prevents foulings and incrustation in the heat exchangers and enhances life of the same. Maintenance/cleaning costs are greatly reduced due to less maintenance requirement.

Al-Qahtani Pipe Coating was the first to offer sakaphen Coating Technology in the Middle East.

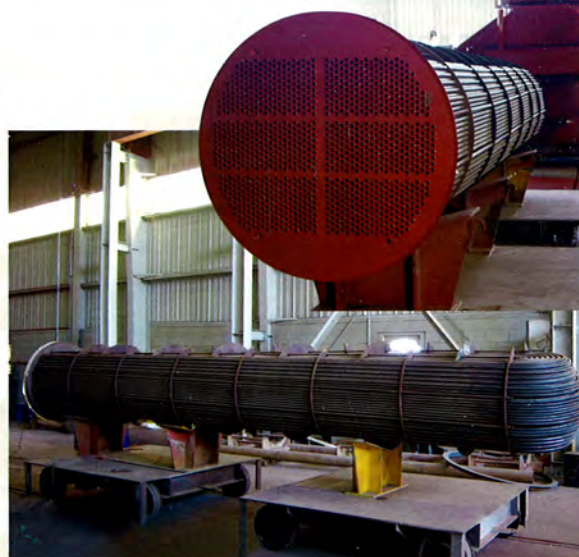

### Internal Cement Mortar Lining

This type of lining/coating can be applied to pipe, fittings and pre-fabricates spoils. The coating is used for potable water.

### Fabrication (welding) of spoils, sleeves

Shop welding has advantages over field welding. Spoils can be welded and coated in the location in ideal conditions.

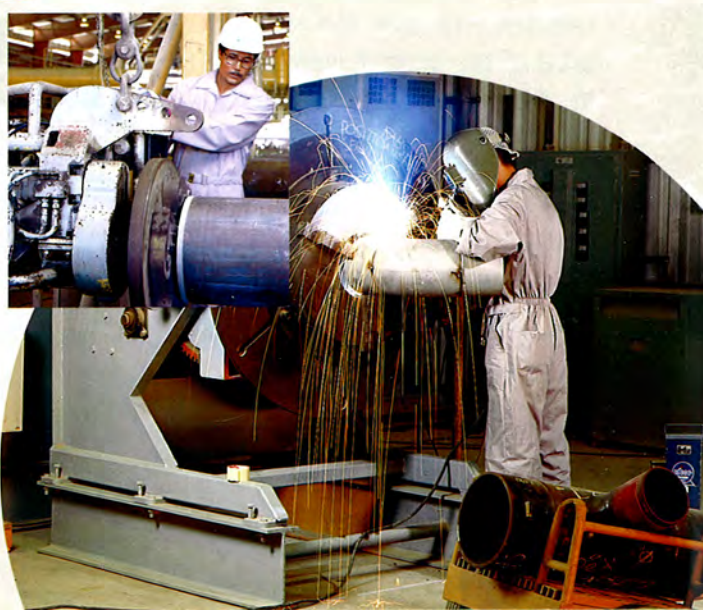

## Pipeline Rehabilitation

Al-Qahtani Pipe Coating line travel equipment for hydro blast cleaning grit preblasting, spray liquid coating of the external surface of pipe. Pipelines where tape coatings or similar coating has failed can be field rehabilitated in situ techniques to remove failed coating and reapplied with liquid coating.

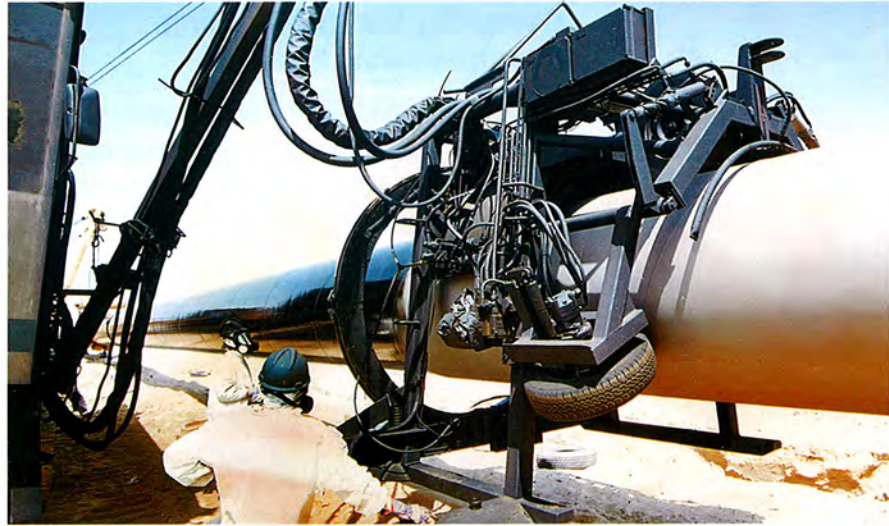

## External Fusion Bonded Epoxy Coating

Al-Qahtani Pipe Coating was the first applicator in the Middle East to apply external fusion bonded epoxy coating from 2" and up to 80", single layer or dual system for stander and high temperature service.

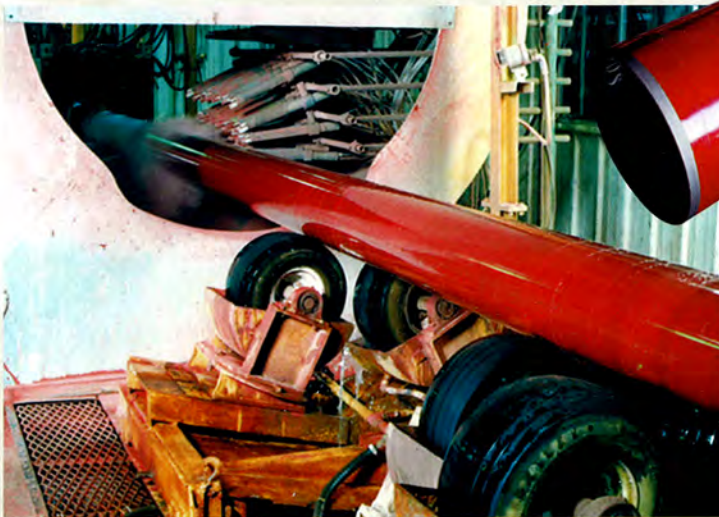



## Concrete Weight Coating (Compression Method)

Concrete coating by compression method is applied to pipe diameters from 3" and upto 60" with coating thicknesses ranging from 1" to 6" and concrete densities is 190 pounds per cubic foot. The compression method can apply concrete coating over any type of corrosion coating FBE, collar and three layer polyethylene or polypropylene.



## Custom Coatings

Al-Qahtani has the most modern and technically advanced facility which includes enclosed manual blasting and conveyor zed oven with automatic speed control for applying external/internal, high temperature liquid and powder coating, to all types of fabricated spools, fittings, bends and valves.



## External Three-Layer Polyethylene/Polypropylene

Al-Qahtani Pipe Coating was the first in the world to apply 3 layer polyethylene coating on 80" diameter pipe for SWCC (Saline Water Conversion Corporation) Water Pipeline Project. 3 layer polyethylene or polypropylene can be applied from 3" and upto 80" diameter.

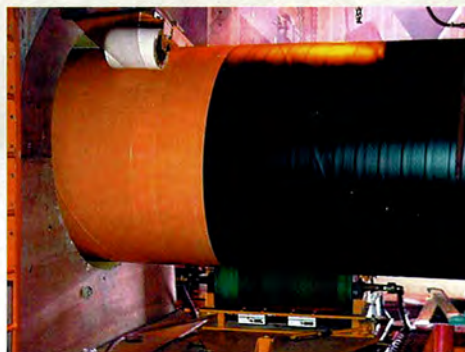
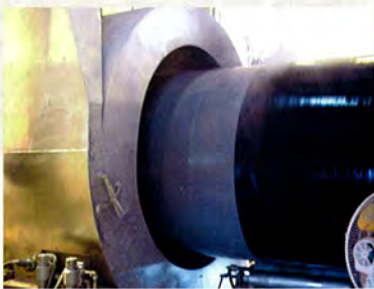

**Contact:**  
Division Manager

P. O. Box 1980, Dammam 31441, Kingdom of Saudi Arabia, Tel.: 966 3 857 4150, Fax: 966 3 857 2255 / 826 9894  
E-mail: info@aqpci.net, Website: www.aqpci.com

**AHQ**



## Group Five Pipe Saudi

A modern factory to supply Saudi Arabia and the neighboring Middle East markets with big-diameter high-quality iron pipes. The various purposes and uses of these pipes include the following sectors:

- 1 Oil & Gas
- 2 Fresh and saline water transportation and related connections.
- 3 Construction and building sector:

The multi-purposes of this sector include:

- Bracing and construction of columns and pillars for buildings, bridges and harbors.
- Thrust boring used to pass pipes & cables under roads and highways.
- Works related to underground tunnels, passageways, ground warehouses, shelters and border blocks.

The Company produces 20 to 160 inch-diameter pipes with thickness starting from 0.24 to 1 inch. Pipes of 20 to 120 inch-diameter are used by the first and second mentioned above sectors while all sizes and diameters are used by the Construction and Building Sector.

An experienced and highly qualified crew of engineers and technicians whose objectives are to achieve the major goals of the Company. These goals include the realization of safety



and production of dependable high quality goods. The quality assurance and maintenance systems and procedures followed by the plant as per the API and ISO 9002 standards support this goal. The plant was awarded a certificate by each of the aforementioned agencies and is licensed to use the API certification.

Plant production started in early June 2001 with an annual production capacity of 67,000 tons of iron pipes but recently increased production to 135,000 tons of iron pipes per year and will achieve 375,000 tons by 4th quarter 2008.

The plant is operated & maintained by highly qualified skilled personnel. The Quality of the raw material manufactured pipes and released pipes are all tested monitored and certified by state-of-the-art laboratories and a highly qualified QA/QC personnel.

The Company has succeeded in producing pipes in fulfillment of the needs of the local market for pipes of big diameter and has exported part of its production to neighboring countries. The Company has crowned its success with the production of the largest iron pipe of its kind ever in the history of the industry with a diameter of 3 meters as a pure Saudi production. The local industry has grown through the use of locally produced iron. Al-Qahtani Pipe Coating Plant has coated the largest pipe in another achievement in the history of the industry proving itself as a pioneer of the industry.

The management of the Company is devoted to the employment of Saudi Graduates of Technical Institutes and Colleges and training them for the purpose of forming an integrated Saudi work crew in advancement of general national directives in realization of the wishes of our wise government to localize jobs.



**Contact:**

Manager Sales Det.

Tel.: 009663123117 Ext. 105, Email: sales@g5ps.com  
P. O. Box 8748, Dammam 31492, Kingdom of Saudi Arabia, Tel.: 966 3 812 3110, Fax: 966 3 812 3122  
E-mail: info@g5ps.com, Website: www.g5ps.com



I  
N  
D  
U  
S  
T  
R  
Y

## Al-Qahtani Nails & Galvanized Wire Factory

**A**l-Qahtani Nails & Galvanized Wire Factory was established in 1983. The Company initially manufactured wooden nails during its early stages of operation but since then it has grown and diversified.

The Factory now produces a wide variety of wire-based products. These include galvanized and armored wire, binding wire, black annealed wire, baling wire, chain link fence fabric, barbed wire and clothes hangers. In 1995, the existing galvanizing plant was extended and a new plant was established for small wires.

Al-Qahtani Nails & Galvanized Wire Factory assures that the quality of its products is of a very high standard on account of using good quality raw materials, a high production system and a qualitative quality control system of highly recommended international standard specifications. The factory became the first resource of its kind to export its products from the Kingdom.

On the other hand, as a result of its stringently followed programs, the factory acquired the merits of the ISO 9002 Certificate.

Al-Qahtani Nails & Galvanized Wire Factory are exporting to the USA, Asia, GCC and other Middle East Countries.

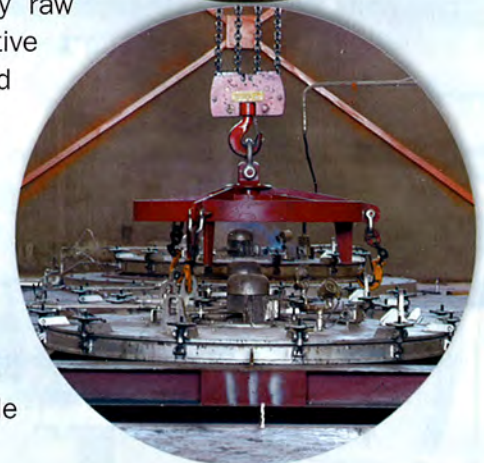

### Contact: Manager

HEAD OFFICE: P. O. Box 11815, Jeddah 21463, Tel.: 966 2 608 0686 / 0694, Fax: 966 2 636 3753 / 966 2 6080671  
RIYADH Sales Office: Tel./Fax: 966 1 241 5204 – ABHA Sales Office: Tel./Fax: 966 7 233 0066  
E-mail: info@ahqwires.com, Website: www.a-gc.net/qahtani





I N D U S T R Y

## Al-Jazira Water Treatment Chemical Factory

We are the sole local Saudi manufacturing and marketing company, a premier world-wide supplier of specialty chemicals for boiler systems, open and closed cooling systems, water and waste water systems and hydrocarbon refinery/ petrochemicals process applications.

We at Al-Jazira are a renowned supplier of engineered water treatment programs, which aid in the operation of plant utilities with automation of boiler, cooling and waste water systems. The result of which enhances productivity, reliability and efficiency in the plant operations. Ultimately the customers meet and exceed compliance requirements with environmental regulations.

Our process treatment facilitate operations in production in petrochemical, gas and power plants, pulp and paper mills, metal and plastics, food processing and mining industries.

Our program ensures that corrosion is prevented, fouling controlled, energy saved, downtime reduced and the finished products quality maintained.



Power Plant



Cooling Tower



Typical steam drum with generating tube baffle plates, centrifugal separators, and secondary scrubbers



Horizontal spray-tray type deaerating heater with storage tank

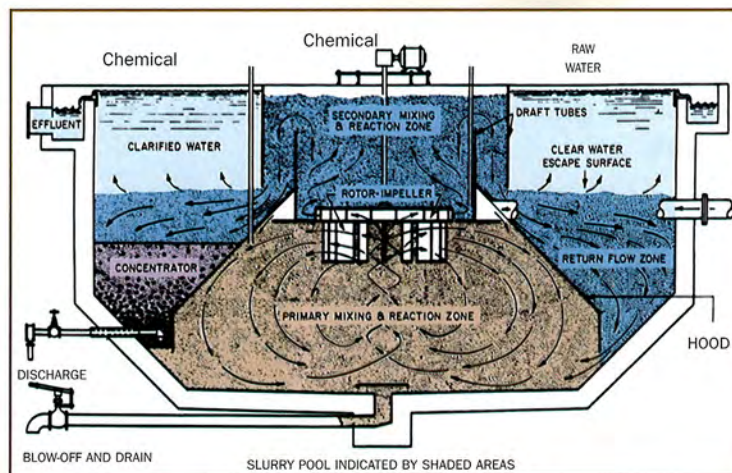

Solids-contact clarifier

**Contact:**  
Manager

P. O. Box 20, Dammam 31411, Kingdom of Saudi Arabia, Tel.: 966 3 856 2573 / 826 1477, Fax: 966 3 850 0350  
E-mail: [info@al-jazirachemicals.com](mailto:info@al-jazirachemicals.com)



## Al-Jazirah Water Company

**A**mongst the wide range of business activities the Al-Qahtani Group embarked with is a new Water Bottling Plant to the existing activities of the Group of Companies. This Bottling Plant combines the most modern technology and experience available, to provide our valued customers with excellent and high quality bottled water.

At present, the company is involved in the production and filling of high quality and unique volume water bottles using the latest technology and innovation available in the world today.

The water produce at this factory goes through several filtration and water treatment stages as per recognized international standards and procedures used by bottling plant, thereby ensuring an end product which is of highest quality. The Bottling Plant has designed new and completely different bottles specifically intended for consumers in Saudi Arabia, which keeps in mind the customers' convenience and water usage requirements. The company continues its expansion as the demand continues to grow high, as well as in accordance to market forecast in line with company policies.



**Contact:**  
Manager

P. O. Box 20, Dammam 31411, Kingdom of Saudi Arabia, Tel.: 966 3 850 2472, Fax: 966 3 850 2759  
E-mail: info@ahqwater.com, Website: www.ahqsons.com



## Southern Gas Company

**E**stablished in 1977 in Khamis Mushayat, the Southern part of Saudi Arabia "ASIR PROVINCE" and owned by the Mother Company.

The plant in the initial stages supplied industrial gases in the area to businesses.

The plant expanded its facilities and activities by including other range of gases and related businesses in the late 1980's.

In addition to the industrial gases, the plant has since 1985 been supplying medical gases to most of the hospitals in the Asir Province.

Range of products and services are as under:

1. Supply of industrial and medical gases.
2. Supply of fire extinguishers, refilling and related services.
3. Supply of welding equipment.
4. Supply of safety equipment and welding gases.
5. Supply of related material and equipment.
6. Supply of safety equipment related to welding and gases.
7. Supply of spare parts and accessories related to the above.



**Contact:**  
Manager

P. O. Box 397, Khamis Mushayt, Kingdom of Saudi Arabia, Tel.: 966 7 227 2471, Fax: 966 7 227 1150  
E-mail: info@ahqgas.com



## Bulk Food Packaging

Highly selected food grain, spices and other food items from local and international growers and exporters are packed in different weights to meet the consumer's demands and needs.

More than one million bags of different sizes and weight of dry food products are electronically weighed, packed and sold yearly.

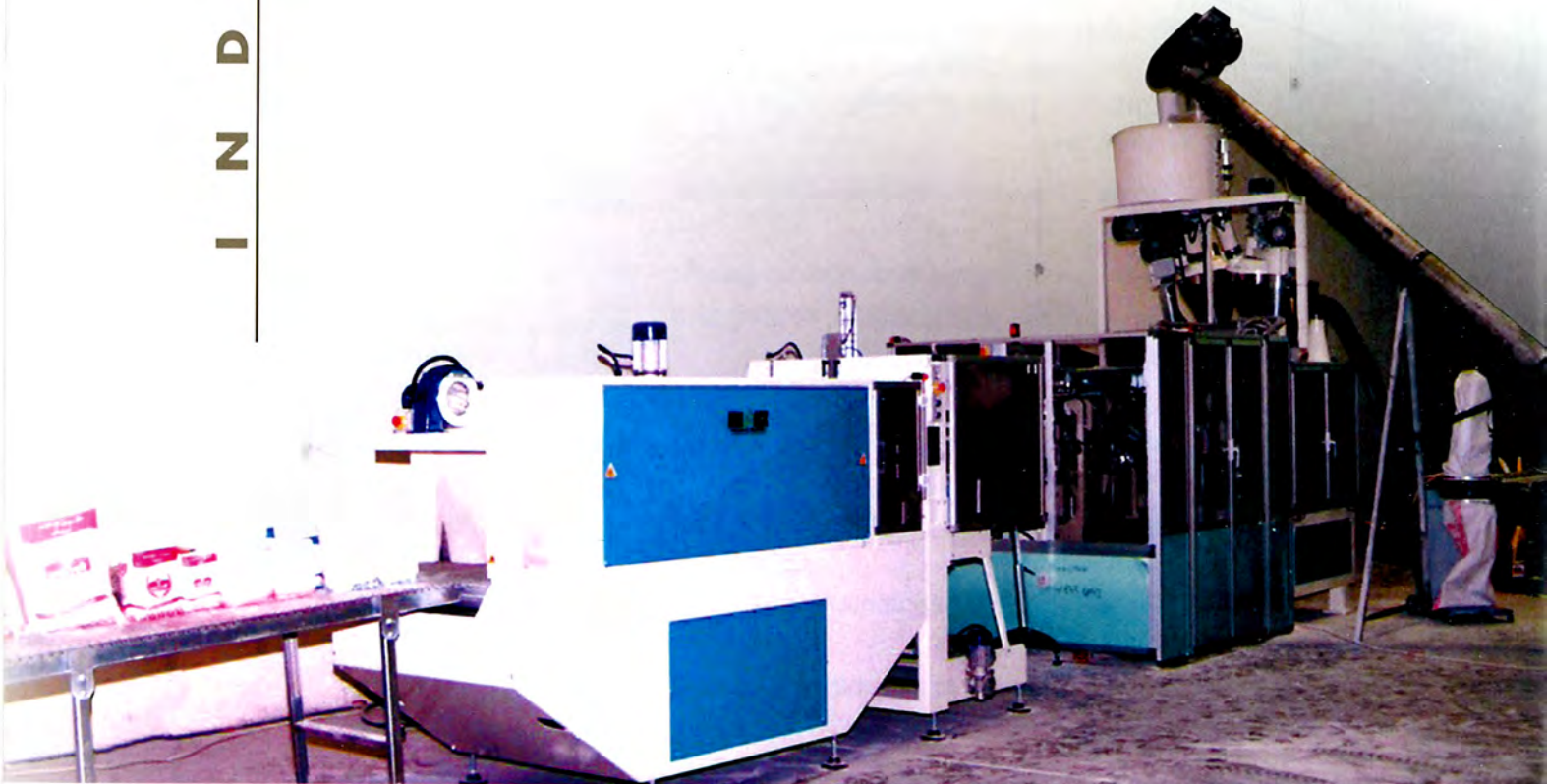

**Contact:**  
Manager

P. O. Box 24, Riyadh 11411, Kingdom of Saudi Arabia, Tel.: 966 1 241 0512, Fax: 966 1 241 8659  
E-mail: [info@ahqsons.com](mailto:info@ahqsons.com), Website: [www.ahqsons.com](http://www.ahqsons.com)



I  
N  
D  
U  
S  
T  
R  
Y

## International Ceiling Systems Factory

The Company is specialized in the manufacturing of high quality suspension systems for all types of false ceilings. The products manufactured are heavy duty and fire rated and adhering to international standards.

Our products of suspension systems include all components of Main Tee, Cross Tee 4", Cross Tee 2" and wall angles in its two forms of 24mm and 15mm exposed systems and are built according to the metric and imperial systems to fulfill the needs and demands of the Saudi as well as the Arabian Gulf Markets.

The products of ICS Company use only high quality hot dipped galvanized zinc coated steel to resist rust and is suitable for all types of weather. The Company also uses high quality of pre-painted steel with a specialized coating that can resist cracks and rust.

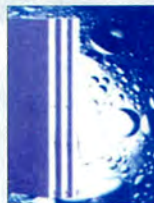

**Contact Us**  
 International Ceiling System  
 P.O. Box: 20  
 Damman 31411, Kingdom of Saudi Arabia  
 00966 3 8587132  
 00966 3 8269894  
 info@icssaudi.info  
 Website: <http://www.icssaudi.info>



### Contact:

Division Manager

P. O. Box 20, Damman 31411, Kingdom of Saudi Arabia, Tel.: 966 3 826 1477 / 1635, Fax: 966 3 826 9894  
E-mail: info@icssaudi.com, Website: www.icssaudi.com







I  
N  
D  
U  
S  
T  
R  
Y

## Riyadh Polypropylene Woven Sacks Co.

It has been the policy of Al-Qahtani group of companies to always diversify business opportunities to meet with new challenges of manufacturing business and subsequently the Group Management decided to enter in the business of woven industry in year 2003. Presently Riyadh Polypropylene Woven Sacks Co. is one of leading unit in this business located in Industrial City of Riyadh. We are currently fulfilling market demand for weaving tubes of lay flat width less than 95cm and sacks with inner liner and have capability to meet the Governemtn local requirement. We are also able to make container bags for loading capacity up to 3000 kg which give us comparative edge over existing manufacturers.

The company has most modern extrusion line for manufacturing of PP fiber with varying denier and strength which is utilized in six shuttle looms for preparing woven sacks of desired dimensions. The company has facility of role to role printing line which enable us to get tremendous production of printing and then through advanced technology of auto cutting line 12 millions finished sacks can be prepared. The Management is willing to expand the capacity of existing line in coming days and also intend to include Kraft paper lamination line to cover cement packaging industry, PP woven net for vegetables, Tarpaulin sheet & woven Geo textiles for construction industry.



### Contact:

Division Manager

P. O. Box 24, Riyadh 11411, Kingdom of Saudi Arabia, Tel.: 966 1 478 1309, Fax: 966 1 478 9901  
E-mail: info@ahqsons.com, Website: www.ahqsons.com



## Güssinger Beverages & Mineral Water GmbH

Since 1815, Güssinger has been a leading producer of mineral water in Austria. Located in the province of South Burgenland, Güssinger has an unspoiled source of rich mineralised water, well known for its health advantages. Güssinger was appointed official mineral water supplier to the court of Kaiser Franz Josef I.

The production facilities at Güssinger can produce mineral water, as well as soft drinks and energy drinks, in both glass and PET bottles. Sizes of bottle vary from 0.25 litre glass to 1.5 litre PET. With four modern production lines, Güssinger can meet both small and large orders with outstanding flexibility. Annually the staff of thirty employees produces more than 20 million bottles at the Güssinger production facilities.

Recently the company has completed a full Re-Launch of the Güssinger brand in Austria. Güssinger also exports to such countries as Slovenia, Croatia, Malta and Germany.



**Contact:**  
Division Manager

Sulz - Austria, Tel.: 004 333 22421210, Fax: 004 333 22421212  
E-mail: ahq@ahqsuisse.ch, Website: www.ahqsons.com

**AHQ**



S E R V I C E S

## Arabian Commercial Services Co.

The office is located in Dammam, the capital of the Eastern Province of Saudi Arabia and conducts insurance Services covering the whole of Saudi Arabia as well as G.C.C. Countries.

Arabian Commercial Services Company is engaged in the Business of insurance since 1970 with the following Coverages of motor vehicles both Comprehensive and Third Party Liability, driving license insurance, marine equipment, Plant and equipment, personal accident, medical insurance, Workmen's compensation, burglary, contractor's general liabilities, machinery breakdown, fire accidents, Cash in Transit and Cash in safe.

The Company offers comprehensive insurance services to the Al-Qahtani Group of Companies and factories and covers such areas as vehicle and marine operation insurance for marine shipments and the transportation sector.

On the other hand, the Company has agreements with International Insurance Companies.



### Contact:

Division Manager

P. O. Box 819, Dammam 31421, Kingdom of Saudi Arabia, Tel.: 966 1 805 1434, Fax: 966 3 826 0819  
E-mail: info@arco-insurance.com





S E R V I C E S

## Abdel Hadi Al-Qahtani Travel Bureau

**A**bdel Hadi Al-Qahtani Travel Agency is one of the first agencies in the Eastern Province and was established in 1972. It is an approved IATA Agent with extensive and in-depth experience in serving the travelling community. It specializes in worldwide flight reservations, Hotel Bookings, Car Rentals, Holiday Packages, International Driving Licenses and other Ground Services.

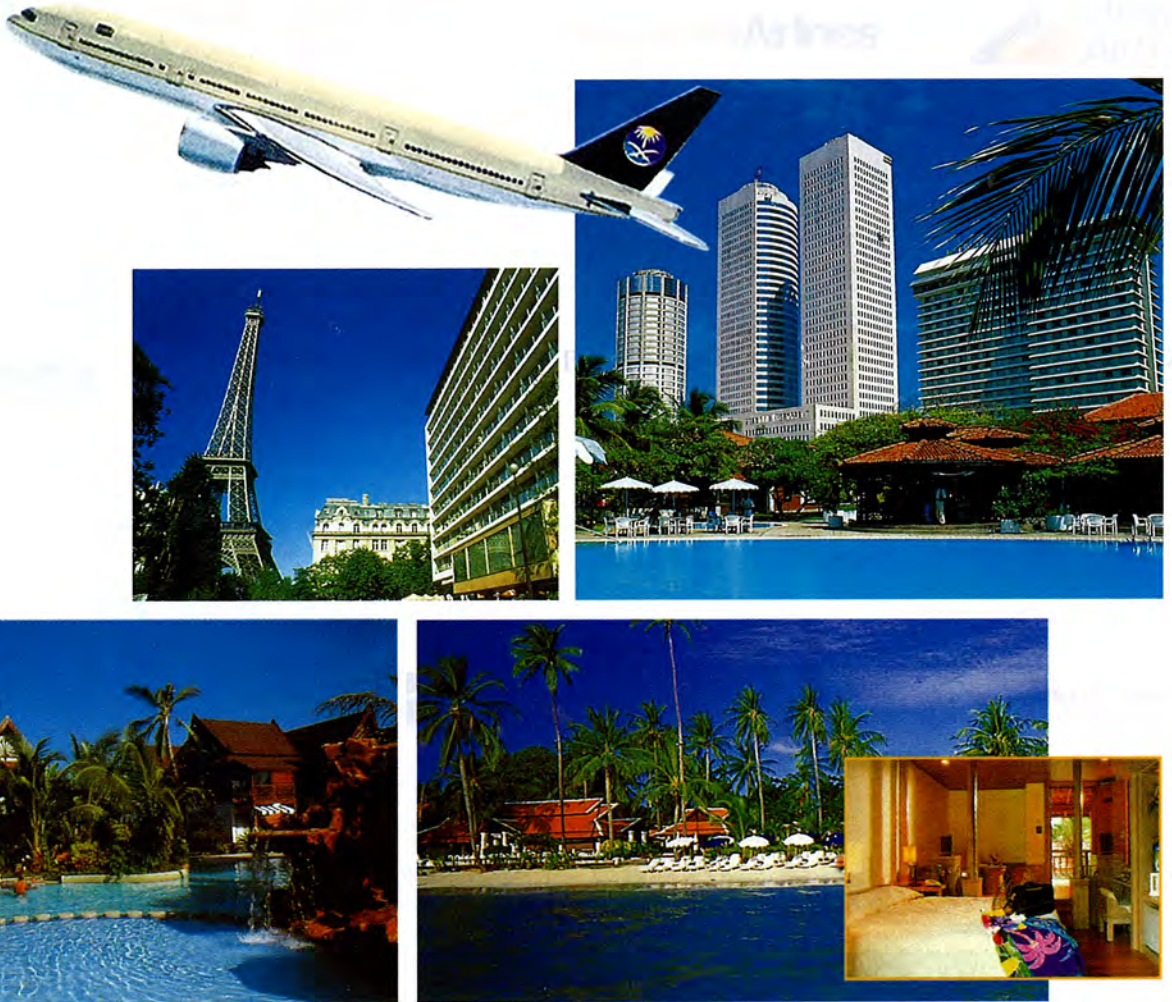

Approved IATA Agent

### Contact:

Division Manager

P. O. Box 20, Dammam 31411, Kingdom of Saudi Arabia, Tel.: 966 3 842 9918, Fax: 966 3 842 9627  
E-mail: [info@al-qahtanitravelbureau.com](mailto:info@al-qahtanitravelbureau.com)





## Earadat Transport Co.

**E**aradat Transport Co. is engaged in various activities and businesses serving its customers not only in Saudi Arabia but also in the G.C.C. countries as well. Primarily they are involved in:

### 1. Custom Clearance:

Earadat Transport Co. is involved in custom clearance activities covering all types of goods and commodities either imported or exported, bulk goods, containers, special consignments and personal shipments. Therefore the Establishment is dealing with all Saudi Airports, seaports and dry land ports.

The Transport Co. also applies follow-ups and obtains custom duty exemption certificates regarding raw material, spare parts, machinery and equipment for industrial projects. Furthermore, Earadat Establishment is also dealing





with custom stores, warehouses located both inside and outside the custom boundaries.

## 2. Transportation:

Earadat Transport Co. owns a modern fleet of 288 tractor heads, 179 trailers, 150 pipe dollies, 80 sulfur tankers and 25 low bed trailers which are kept in excellent working condition by a well equipped workshop staffed by a team of highly professional technicians and mechanics. The workshop is responsible to ensure that vehicles are available at all times and are ready to absorb the customers needs and requirements anywhere in Saudi Arabia. They follow a strict compliance of safety rules and regulations and consider no job too big or small or any destination out of reach.

Reputation and excellent performance blended together with a commitment to serve our customers has placed Earadat Transportation on a path of growth.

## 3. Other Activities:

Earadat Transport Co. also owns a number of excavators and dumpers that are available for lease to other companies which are working in the field of pipeline contracting.



## Contact:

Division Manager

P. O. Box 2010, Dammam 31451, Kingdom of Saudi Arabia, Tel.: 966 3 827 2991, Fax: 966 3 827 5393  
E-mail: info@earadat-transport.com





## Shams Al-Jazirah School (Girls)

**A** I-Qahtani Group of Companies established Al-Shams National School in 1999 at Dammam City.

### Teachers, Parents, Students, Together Achieve More ...

- Our program consists of language literature, social studies, science, and math. All these subjects are our overall goals to nurture the growth of a young child to become a self reliant and self confident person, to prepare her for academic professionalism.
- There is an Intensive Course for students who need to improve their English Skills.
- Our school opens the doors of multiple indoor and outdoor activities, such as, Spelling Bee Contest, P.E activity and trips.
- School offers transportation for students in Al Khobar and Al Dammam.
- With you we distinguish our achievement.



### Contact:

Division Manager

P. O. Box 2010, Dammam 31451, Kingdom of Saudi Arabia, Tel.: 966 3 842 3544 / 843 3435, Fax: 966 3 842 8766





## Abdel Hadi Abdullah Al-Qahtani & Sons Farms

The Abdel Hadi Abdullah Al-Qahtani & Sons Farms was established in 1954 in Riyadh and subsequently with the passage of time expanded to Dammam and Abha as well. It covers the following activities:

### 1. Production of Grain Crops:

Saudi Wheat, of which the Farm plants 500 - 700 hectares annually as well as Barley, Elymus Arenarius (for the first time in the Arabian Peninsula) and Maize - Corn (both white and yellow).

### 2. Production of Fodder, Sugar and Oil Production Corps:

Medicago sativa, Rhodes grass, Fodder-beet, Sugar cane and beet, Peanut, Sun rose (Helianthemum) and Sesame.

### 3. Palm Trees:

At this first stage, about 20 tons of special (high quality) dates are produced annually (local types include Khlass - Sukkari - Barhhi - Wannan and Rothana). This quantity will be doubled in the coming years.

### 4. Equatorial Fruits:

Production of citrus fruits, annona (equatorial fruit), various types of papaya and special types of grapes.

### 5. Livestock Production:

- 1 Breeding of pedigree horses (Arabian Horses).
- 2 Breeding and fattening of sheep and camel.
- 3 Culturing and production of local domesticated birds (such as chicken, pigeons - ducks - quails and turkeys).
- 4 Farming of Nile child and most fresh water fishes.



### Contact:

Manager

P. O. Box 3664, Riyadh 11481, Kingdom of Saudi Arabia, Tel.: 966 1 478 1309 / 1480, Fax: 966 1 478 9901







## Saudi Arabian Overseas Services Inc. (SAOSI)

**S**audi Arabian Overseas Services Inc. (SAOSI) was established in Houston Texas (USA) in 1976. Considered the American Energy Capital and at the same time viewed as strategically the best commercial site in North America (SAOSI) was established to target the following areas:

- 1 To have a permanent location in the United States of America for managing the business in U.S.A.
- 2 To support and expand the relationship with the American Businessmen who are working in the commercial and industrial fields so as to better exchange the benefits and services between the USA and the Middle East.
- 3 To use the SAOSI Office in the U.S.A. as an agent for the Al-Qahtani Group of Companies and for being responsible for conducting commercial transactions with American Manufacturers and Suppliers and for supervising shipments of orders placed from Saudi Arabia. A pivotal role of SAOSI is also to develop new partnerships and joint ventures with North American Companies interested in doing business in Saudi Arabia.
- 4 Conducting studies of the U.S. markets and keeping us informed of new and modern developments and innovations that can benefit the oil gas and agricultural sectors of Saudi Arabia.
- 5 The SAOSI Office maintains an updated database of American suppliers and businessmen with their contact numbers, type of business activities and products and services they deal in.
- 6 A new and modern electronic system was set up in the SAOSI office to answer questions and inquiries relating to the business activities, banking and economic affairs.
- 7 The SAOSI Office also manages real estate owned by the Group in the U.S.
- 8 Arranging invitations for businessmen from the U.S. to Saudi Arabia and vice versa are also handled by the SAOSI Office.



### Contact:

Manager

Saudi Arabian Overseas Services, Inc. 5718 Westheimer, Suite 1515, Houston TX 77057, USA Tel.: 001 713 781 0366, Fax: 001 713 781 1344, E-mail: [info@saosi.com](mailto:info@saosi.com), Website: [www.saosi.com](http://www.saosi.com)



## Head Office, Branches and Overseas Offices

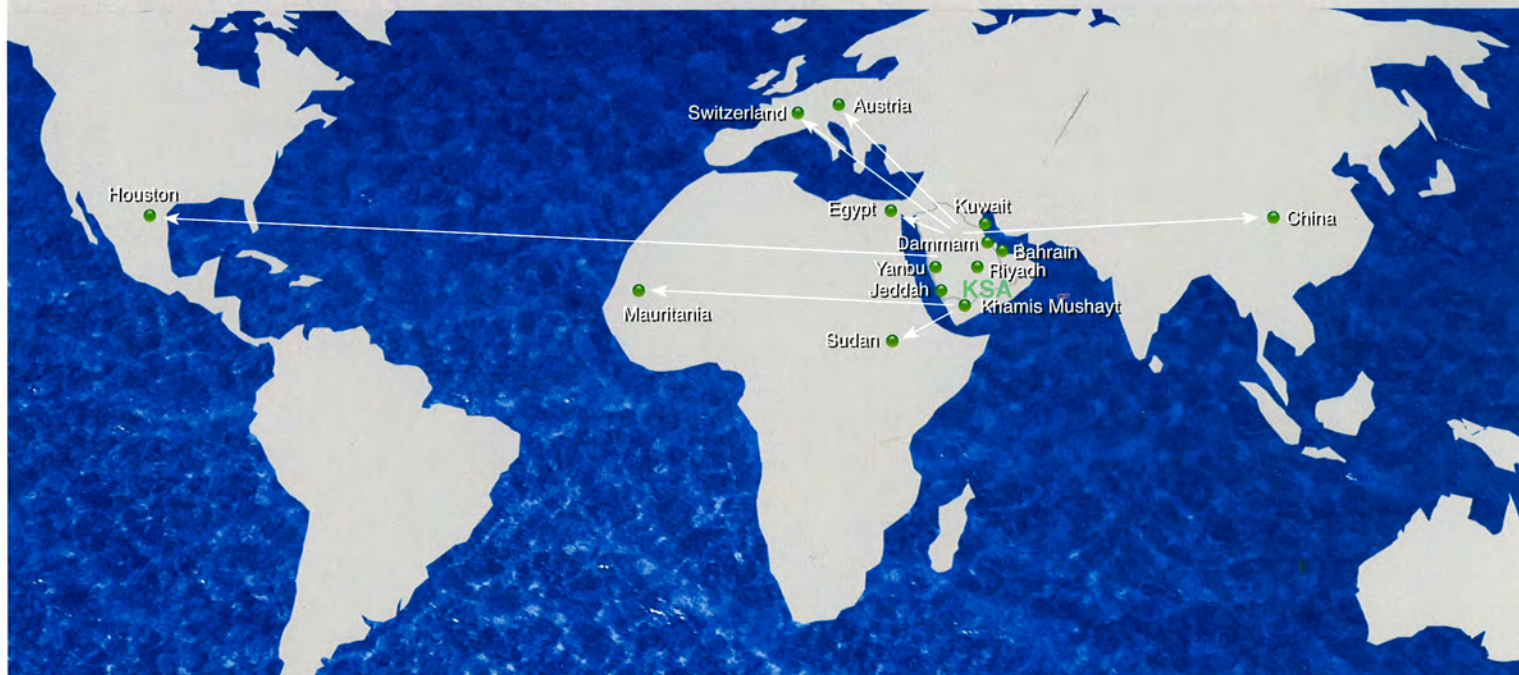

### Group Head Office Address:

P. O. Box 20 Dammam 31411, Saudi Arabia  
 Tel.: (966-3) 8261477 / 8261635 – Fax: (966-3) 8269894  
 E-mail: info@ahqsons.com, Website: www.ahqsons.com

### Branches Kingdomwide:

#### Riyadh

P. O. Box 24, Riyadh-11411, Tel.: 01-2410512,  
 Fax: 01-2418659

#### Jeddah

P. O. Box 11815, Jeddah 21463, Tel.: 02-6080686,  
 Fax: 02-6363753

#### Yanbu

P. O. Box 30362, Jeddah Road, Light Ind. City, Tel.: 04-3968790,  
 Fax: 04-3968517

#### Khamis Mushayt

P. O. Box 397, Khamis Mushayt, Tel.: 07-2276283,  
 Fax: 07-2271150

### Overseas Office Address:

#### USA Office

Saudi Arabian Overseas Services Inc., Houston – USA  
 Tel.: +1(713) 781 0366 – Fax: +1(713) 781 1344  
 E-mail: info@saosi.com, Website: www.saosi.com

#### A.H.Q. Suisse SA

12, Rue de Chantepoulet, 1201 Geneve- Switzerland,  
 Tel.: 0041229069999, Fax: 0041229069998,  
 E-mail: ahq@ahqsuisse.ch

#### H.T. International for General Trading & Contracting

P.O. Box: Hawalli 4159, Postal Code: Hawalli 32072 - Kuwait  
 Al Farwannah - Sabihah Business Group, 114 Street,  
 Block 25, Ext. 8 - Office # 1 - 1st Floor,  
 Tel.: 009654767510, Fax: 009654752582

#### Bahrain Office

P.O. Box: 935 Manama, Kingdom of Bahrain, Tel.: 0097317311393  
 Fax: 0097317311014, E-mail: ahqsons@batelco.com.bh /  
 bahrain@ahqsons.com

#### Egypt Office

7A, Abou Simbel St., Heliopolis, Cairo 11351  
 Tel.: 0020226321821, Fax: 0020226442071

#### Sudan Office

Sudan – Khartoum – Riyadh Block 18 Building 69  
 P.O. Box 101 Tel.: 00249154947901, Fax: 00249183230905

#### Austria Office

Suiz - Austria, Tel.: 004 333 22421210,  
 Fax: 004 333 224212112, E-mail: ahq@ahqsuisse.ch

#### China Office

Jushang V8 1-14-5, Donghuan Road No 230  
 Liuzhou, Guangxi, P.R. China  
 Tel.: 00867723599985, Fax: 00867723599237, Mob.:  
 008613977293299

#### Nooukchott - Mauritania

w w w . a h q s o n s . c o m

**Group Head Office Address:**

P. O. Box 20 Dammam 31411, Saudi Arabia  
Tel.: (966-3) 8261477 / 8261635 – Fax: (966-3) 8269894  
E-mail: info@ahqsons.com

**USA Service Office:**

Saudi Arabian Overseas Services Inc.,  
Houston – USA  
Tel.: +1(713) 781 0366 – Fax: +1(713) 781 1344  
E-mail: info@saosi.com  
Website: www.saosi.com